

Armadio ante scorrevoli tetto inclinato

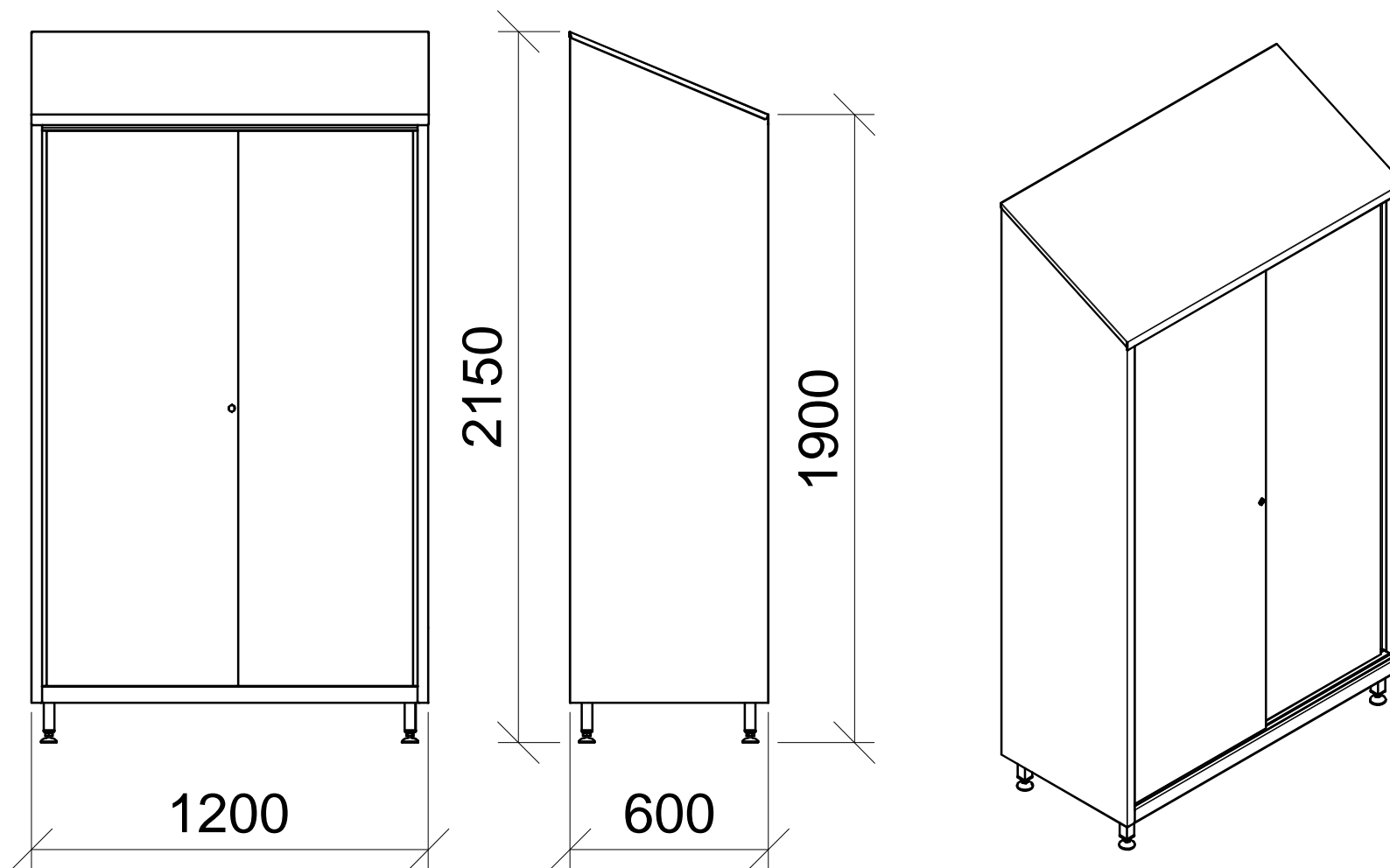

Caratteristiche:

- in acciaio inox sp. 1.0mm;
- finitura spazzolata 2J (Scotch-Brite®);
- tetto inclinato;
- serratura a chiave;
- 4 ripiani regolabili;
- ganci in acciaio inox.

Codice: X6008

FACILITAS

via Lazio 7 A/B/C - 41050 Montale Rangone (MO)
Web: www.facilitas.it @: facilitas@facilitas.it
Tel: +39-059-530570 Fax: +39-059-4909000